

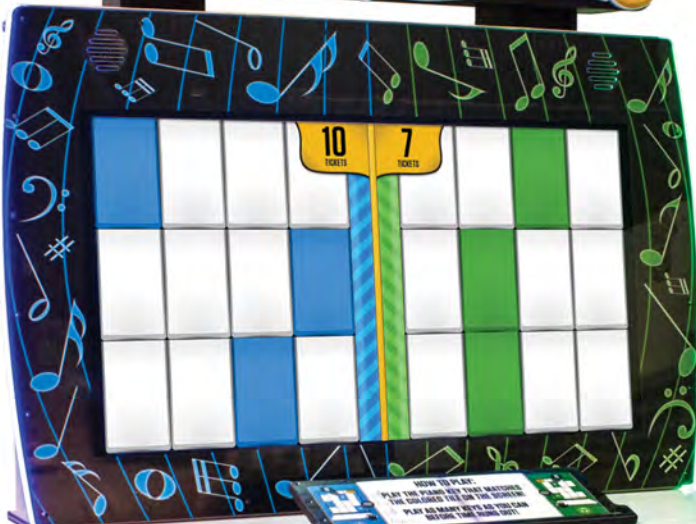

Grand PIANO KEYS



HOW TO PLAY
PLAY THE PIANO KEY AND MATCHES
THE COLORED KEY ON THE BOARD.
PLAY AS MANY KEYS AS YOU CAN
BEFORE THE MUSIC STOPS.



PLACE SERIAL NUMBER LABEL HERE



FACTORY CONTACT INFORMATION



BAY TEK GAMES INC.
Pulaski Industrial Park
1077 East. Glenbrook Drive
Pulaski, WI 54162 USA

JOIN OUR SERVICE FIRST NETWORK!

This free service is intended to keep you up to date on the latest game information, early notification of parts specials, pertinent technical bulletins, updates on retro fit parts, software upgrades, and much more.

Log on to: www.baytekgames.com/parts
then click on the Parts N' Service tab, or scan the QR code below with your Smartphone to jump straight to this game's parts page!

Scan here!



SALES

P: 920.822.3951

F: 920.822.8936

E: sales@baytekgames.com

PARTS

P: 920.822.3951 X 1101

F: 920.822.1496

E: parts@baytekgames.com

SERVICE

P: 920.822.3951 X 1102

F: 920.822.1496

E: service@baytekgames.com

MON - FRI
8 AM - 5 PM C.S.T.

All games are proudly manufactured at our factory in Pulaski, Wisconsin, USA

TABLE OF CONTENTS

| | |
|--|-------|
| FACTORY CONTACT INFORMATION | 2 |
| WELCOME TO: Grand Piano Keys | 4 |
| HOW TO PLAY | 5 |
| SPECIFICATIONS | 6 |
| SAFETY PRECAUTIONS | 6 |
| DIP SWITCH SETTINGS | 7 |
| QUICK SET UP GUIDE | 8-10 |
| MAIN MENU | 11 |
| PAY IN/OUT MENU | 12 |
| GAME SETTINGS MENU | 13 |
| SONG BOOK | 14 |
| STATISTICS/DIAGNOSTICS | 15 |
| NEWGEN BOARD PINOUT | 16 |
| WIRING DIAGRAMS | 17-23 |
| TROUBLESHOOTING GUIDE | 24-29 |
| MONITOR TROUBLESHOOTING | 30-31 |
| HOW TO: ACCESS KEYS & SENSORS | 32 |
| HOW TO: INSTALL/UPDATE SOFTWARE | 32 |
| MOTHERBOARD & POWER SUPPLY DIAGNOSTICS | 33 |
| BILL ACCEPTOR DIAGNOSTICS | 34 |
| DEBIT CARD SYSTEM SETUP | 35 |
| PARTS LISTS | 36-38 |
| DECAL IDENTIFICATION | 39 |
| MAINTENANCE LOG | 40 |
| TECHNICAL SUPPORT | 41 |
| WARRANTY | 42 |

WELCOME TO: Grand Piano Keys

Congratulations on your GRAND PIANO KEYS purchase!

Grand Piano Keys' beautifully lit, attention-grabbing cabinet and marquee along with the fun and simple game play will have aspiring musicians flocking back time and again to beat their high scores!

With the option of a 1-player solo or a 2-player duet, the competitive nature and player-paced play of Grand Piano Keys appeals to all ages. Simply hit the oversized novelty key that matches the colored square on the screen to play a variety of well-known tunes, accumulating tickets as you go! The faster and more accurately you play, the more tickets you win!

Please take a moment to read through this manual and be sure to contact our factory if you have any questions, or would like some more information.

Thank you for your purchase! Your business is important to us and we hope you enjoy this game as much as we do!

Your Friends at Bay Tek Games



GAME INSPECTION

Inspect the game for any damaged, loose, or missing parts.

If damage is found, please contact your freight carrier first.

Then, contact Bay Tek Games' Service Department at 920.822.3951 or e-mail them at service@baytekgames.com for further assistance.

HOW TO PLAY

Have a seat on the piano bench and insert your credits.



Follow the colored squares on the screen to play a solo or duet on the oversized keys.



The faster and more accurately you play, the more tickets you win!



Play again to beat your high score.



GAME SPECIFICATIONS

| WEIGHT | |
|-----------------------|-----------------------|
| NET WEIGHT | 850 LBS. |
| SHIP WEIGHT | 995 LBS. |
| DIMENSIONS | |
| WIDTH | 66" |
| DEPTH | 72" (44" no bench) |
| HEIGHT | 111" (80" no marquee) |
| OPERATING TEMPERATURE | |
| FAHRENHEIT | 80-100 |
| CELSIUS | 26.7-37.8 |

| POWER REQUIREMENTS | | | |
|-----------------------|----------------|---|----------------|
| INPUT VOLTAGE RANGE | 100 to 120 VAC | / | 220 to 240 VAC |
| INPUT FREQUENCY RANGE | 50 HZ | / | 60 HZ |

| MAX START UP CURRENT | OPERATING CURRENT |
|----------------------|--------------------|
| 3.5 AMPS @ 115 VAC | 2.6 AMPS @ 115 VAC |
| 1.75 AMPS @ 230 VAC | 1.3 AMPS @ 230 VAC |

SAFETY PRECAUTIONS

| NOTICE | |
|---|--|
| <p>Modifications to the mechanical, electrical and structural components of this game may void its compliance certifications.</p> <p>This appliance is suitable for INDOOR, DRY locations only.</p> | |
| DANGER | |
| <p>DO NOT perform repairs or maintenance on this game with the power ON. Unplug the unit from the wall outlet or shut off the power strip located inside the cabinet.</p> | |
| WARNING | |
| <p>Use of flammable substances can cause sever burns or serious injury. Always use NON-FLAMMABLE solvents for cleaning. DO NOT use gasoline kerosene or thinners.</p> | |
| CAUTION | |
| <p>Lifting heavy objects can cause back, neck or other injuries. Be sure adequate lifting and moving devices are available when unloading, unpacking and moving this game.</p> | |
| ATTENTION | |
| <p>Be sure the electrical power matches the game requirements. See the serial number located on the back of the game cabinet. Always plug into a grounded circuit. If the supply cord is damaged, it must be replaced by an approved cord or assembly provided by the manufacturer.</p> <p>A shielded power cable must be used for the game to retain EU/EMC compliance.</p> | |
| IN CASE OF EMERGENCY | |
| <p>UNPLUG THE POWER CORD.</p> <p>The power cord must be accessible at all times in case of an emergency.</p> | |

DIP SWITCH SETTINGS

THE DIP SWITCHES ARE LOCATED ON THE MINIGEN BOARD.
 PULL OUT THE CENTER DRAWER IN THE FRONT OF THE CABINET TO ACCESS.
 DEFAULT SETTINGS ARE HIGHLIGHTED BELOW.

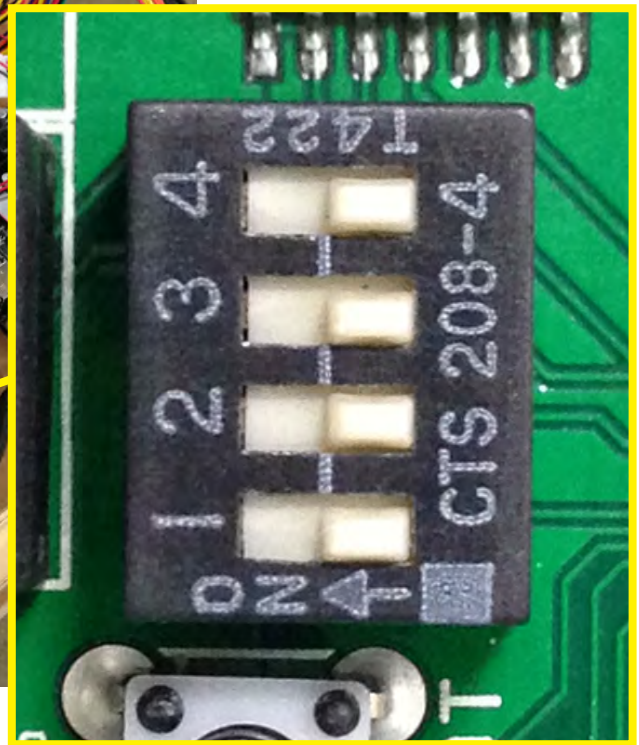
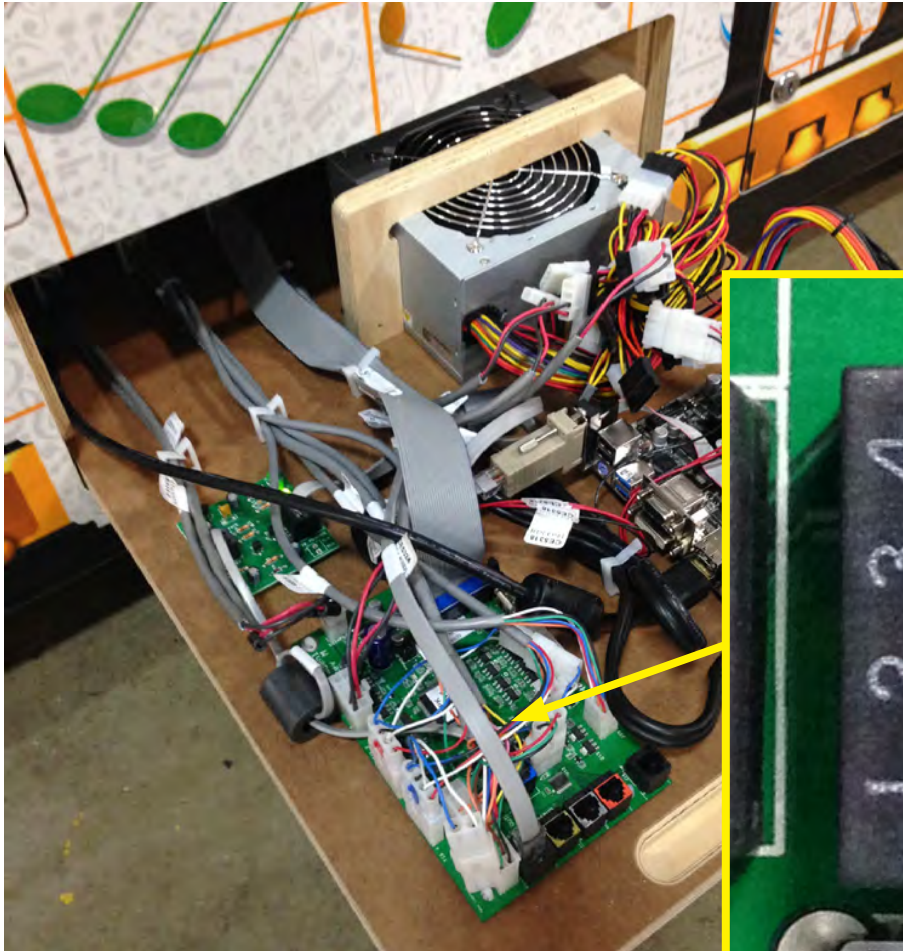

| SWITCH | DESCRIPTION | ON | OFF |
|--------|---|----|-----|
| 1 | Marquee Bulb type (do not adjust) | | |
| 2 | Stored Credits/Tickets Owed (on power cycle) | | |
| 3 | not used | | |
| 4 | not used | | |

QUICK SET UP GUIDE

Place the game near its final location and remove the back doors, setting them aside.



Attach the music stand instruction panel by inserting the tabs into the top of the cabinet and sliding it towards the bench.



Secure with included Phillips bolts and washers.

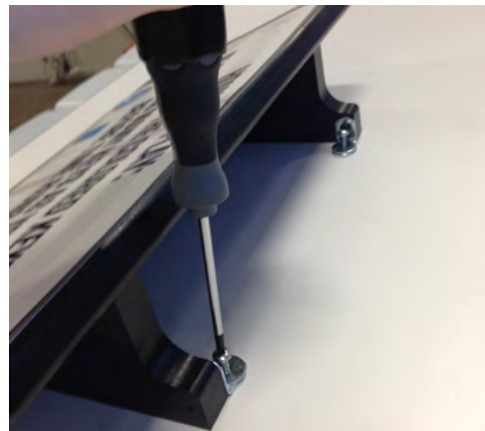

Push the bench up to the cabinet and secure it in place with included bolts and washers (3 total).

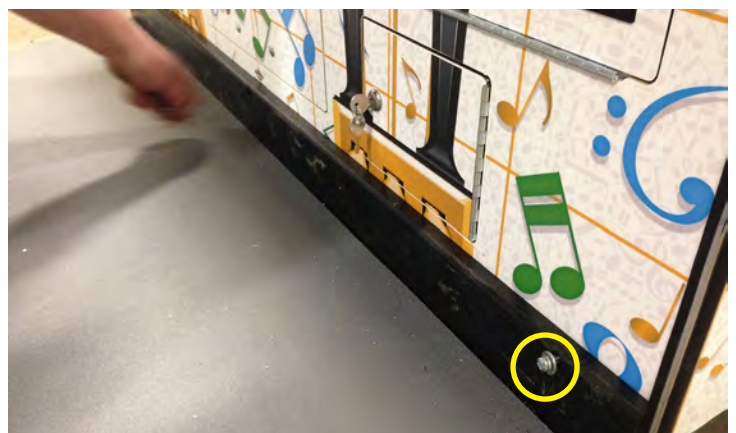

QUICK SET UP GUIDE

Buddy-lift the marquee into place on top of the cabinet. Secure the marquee in place with included bolts and washers.



Feed the cables from the upper left corner of the cabinet up through the hole and into the marquee.

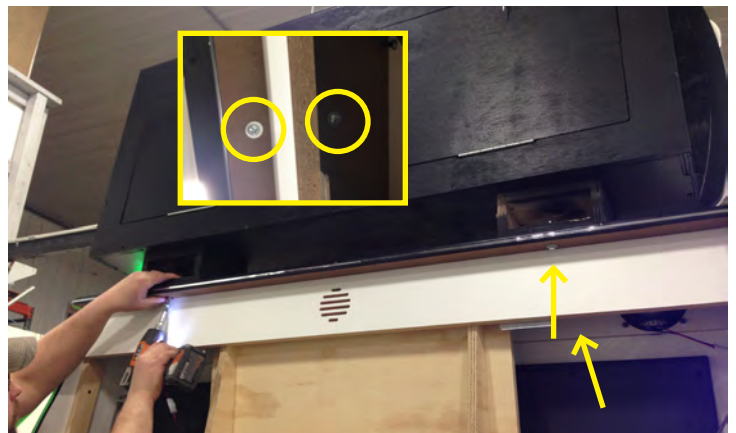

Plug in the cables as shown here and on the next page.

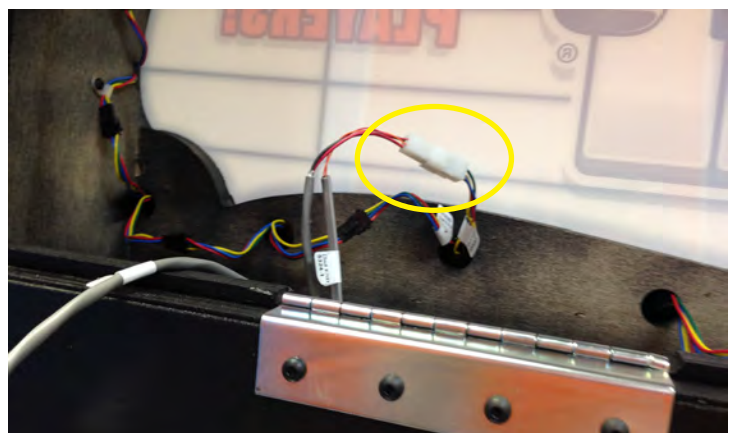

QUICK SET UP GUIDE

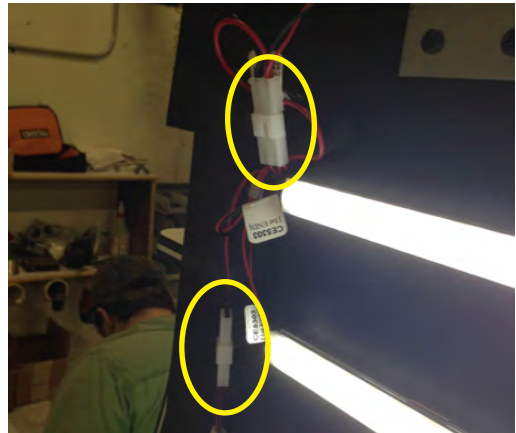

Replace the back doors and plug the game into a standard electrical outlet.



MAIN MENU

Hold down the **MENU** button inside the front door of the cabinet for 2 seconds to open the main menu on the monitor.

Press **MENU** to scroll through the options, and **SELECT** to choose your settings.



| MAIN MENU | | | | | | | | | | | |
|--------------------------|------------------------------------|----|--------|----|--------|----|---------|----|-----------|----|-----|
| GAME VOLUME | 0 | 10 | 20 | 30 | 40 | 50 | 60 | 70 | 80 | 90 | 100 |
| ATTRACT VOLUME | 0 | 10 | 20 | 30 | 40 | 50 | 60 | 70 | 80 | 90 | 100 |
| ATTRACT TIMING | 30 SEC | | 60 SEC | | 90 SEC | | 120 SEC | | ALWAYS ON | | |
| CLEAR CREDITS/TICKETS | PRESS MENU BUTTON 3 TIMES TO CLEAR | | | | | | | | | | |
| RESTORE FACTORY SETTINGS | PRESS MENU BUTTON 3 TIMES TO RESET | | | | | | | | | | |

PAY IN/OUT MENU

PAY IN/OUT MENU

Credits: 4

Payout Pattern: #9 - 3 TICKETS EVERY 4 KEYS (AVG:30) _-1_-2-

Card Reader: NONE

Divide By 2: DISABLED

Fixed Ticket Payout: NOT FIXED

Ticket Cap: NONE

Regular/Show Mode: REGULAR MODE

Back

| PAY IN/OUT MENU | | | | | | | | | | | | |
|---------------------|------------------|---|---|----|--------------------------|----------|-------------------------|------|---|---|----|--|
| CREDITS PER PLAY | 0 | 1 | 2 | 3 | 4 | 5 | 6 | 7 | 8 | 9 | 10 | |
| PAYOUT PATTERN | *SEE CHART BELOW | | | | | | | | | | | |
| CARD READER | ENABLED | | | | | DISABLED | | | | | | |
| DIVIDE BY 2: | ENABLED | | | | | DISABLED | | | | | | |
| FIXED TICKET PAYOUT | NOT FIXED | | | | | 2 | TO (INCREMENTS OF 2) | | | | 50 | |
| TICKET CAP | NONE | | | 50 | TO (INCREMENTS OF 50) | | | 1000 | | | | |

| *PAYOUT PATTERNS | | | |
|------------------|----------------------------|----------|-----------------|
| PATTERN | TICKETS PER | KEYS HIT | AVERAGE TICKETS |
| 0 | NO TICKETS- AMUSEMENT ONLY | | |
| 1 | 1 | 10 | 4 |
| 2 | 1 | 5 | 8 |
| 3 | 1 | 3 | 13 |
| 4 | 2 | 5 | 16 |
| 5 | 1 | 2 | 20 |
| 6 | 4 | 7 | 23 |
| 7 | 5 | 8 | 25 |
| 8 | 4 | 6 | 27 |
| 9 | 3 | 4 | 30 |
| 10 | 7 | 8 | 35 |
| 11 | 5 | 4 | 50 |
| 12 | 7 | 4 | 70 |

GAME SETTINGS

GAME SETTINGS MENU

Time Per Game: 20 SECONDS

Fine Tune Payout: 0.5 SEC LONGER Game Time (about 1 more key hit per game)

Payout Type: TICKETS

Game Start Timeout: 30 SECONDS

Back



| GAME SETTINGS | | | | | | | | | | | | |
|------------------------------|------------|----|------|----|--------|----|------|----|---------|----|------|--|
| *TIME PER GAME (SECONDS) | 10 | 15 | 20 | 25 | 30 | 35 | 40 | 45 | 50 | 55 | 60 | |
| FINE TUNE PAYOUT (SECONDS) | -2.5 | -2 | -1.5 | -1 | -0.5 | 0 | +0.5 | +1 | +1.5 | +2 | +2.5 | |
| PAYOUT TYPE | TICKETS | | | | POINTS | | | | COUPONS | | | |
| GAME START TIMEOUT (SECONDS) | 0 (off) | 10 | 20 | 30 | 40 | 50 | 60 | | | | | |

*TIME PER GAME DIRECTLY AFFECTS PAYOUT
(APPROXIMATELY 2 KEYS PER SECOND)

SONG BOOK

SONGBOOK MENU

Next Song >>

Prev Song >>

Disable / Enable Song

Back

Chopsticks
Enabled



| SONG BOOK | | |
|----------------------|---------|----------|
| DEMO SCALE | ENABLED | DISABLED |
| FUR ELISE | ENABLED | DISABLED |
| BA BA BLACK SHEEP | ENABLED | DISABLED |
| CAN CAN | ENABLED | DISABLED |
| TWINKLE TWINKLE | ENABLED | DISABLED |
| TEN GREEN BOTTLES | ENABLED | DISABLED |
| C3 | ENABLED | DISABLED |
| ODE TO JOY | ENABLED | DISABLED |
| AULD LANG SYNE | ENABLED | DISABLED |
| CHOPSTICKS | ENABLED | DISABLED |
| HAPPY BIRTHDAY | ENABLED | DISABLED |
| STAR SPANGLED BANNER | ENABLED | DISABLED |

STATISTICS

STATISTICS MENU

Total Games: 32

Total Games Left: 21

Total Games Right: 11

Total Tickets: 383

Average Tickets: 11

Keys Played: 469

High Score: 20

HS Beat: 0

Reset Stats: 3x's

Reset High Score: 3x's

Back

DIAGNOSTICS

DIAGNOSTICS MENU

Menu Button: Up

Select Button: Up

P1 Key 1: Up

P1 Key 2: Up

P1 Key 3: Up

P1 Key 4: Up

P2 Key 1: Up

P2 Key 2: Up

P2 Key 3: Up

P2 Key 4: Up

Back

IF THERE HAS BEEN A MINIGEN COMMUNICATION ERROR, A MESSAGE WILL DISPLAY
ACROSS THE BOTTOM OF THE SCREEN

NEWGEN PINOUT GUIDE

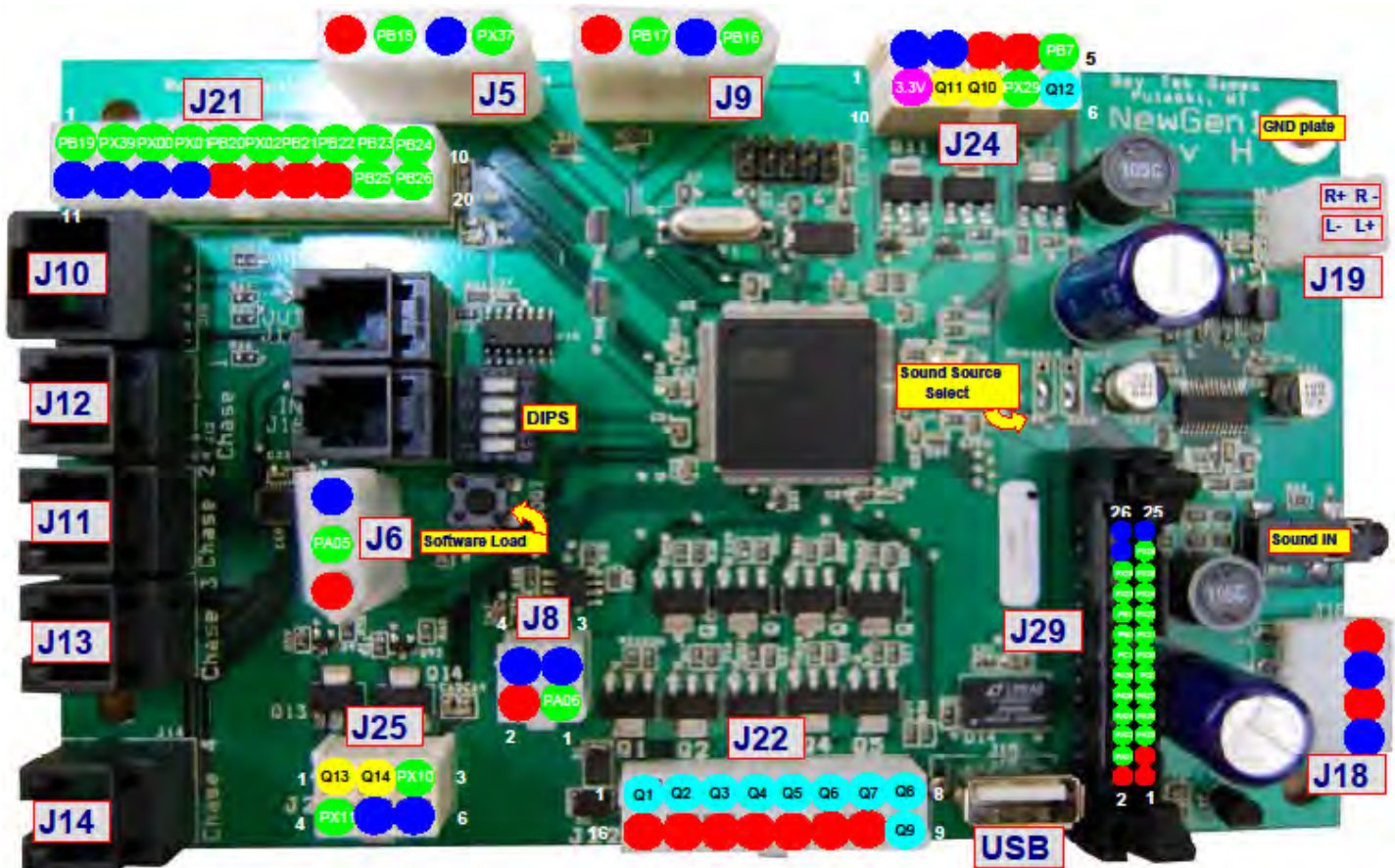

- Ground
- +12V
- Low Side Driver
- High Side Driver
- TTL Logic
- +3.3V



SPI Out - Display - (J10)

- Pin 1 & Pin 3 - +12V
- Pin 2 - SCLK_BUS2
- Pin 4 - SMOSI_BUS2
- Pin 5 & Pin 7 - Ground
- Pin 6 - SCS2_BUS2
- Pin 8 - SMISO_BUS2

Chase Lights (J11,J12,J13,J14)

- Pin 1 - Chase Output
- Pin 2 - Chase Output
- Pin 3 - +12V
- Pin 4 - Chase Output
- Pin 5 - Chase Output
- Pin 6 - +12V

WIRING DIAGRAMS

NEWGEN (AANEWGEN1-JP/RBN)

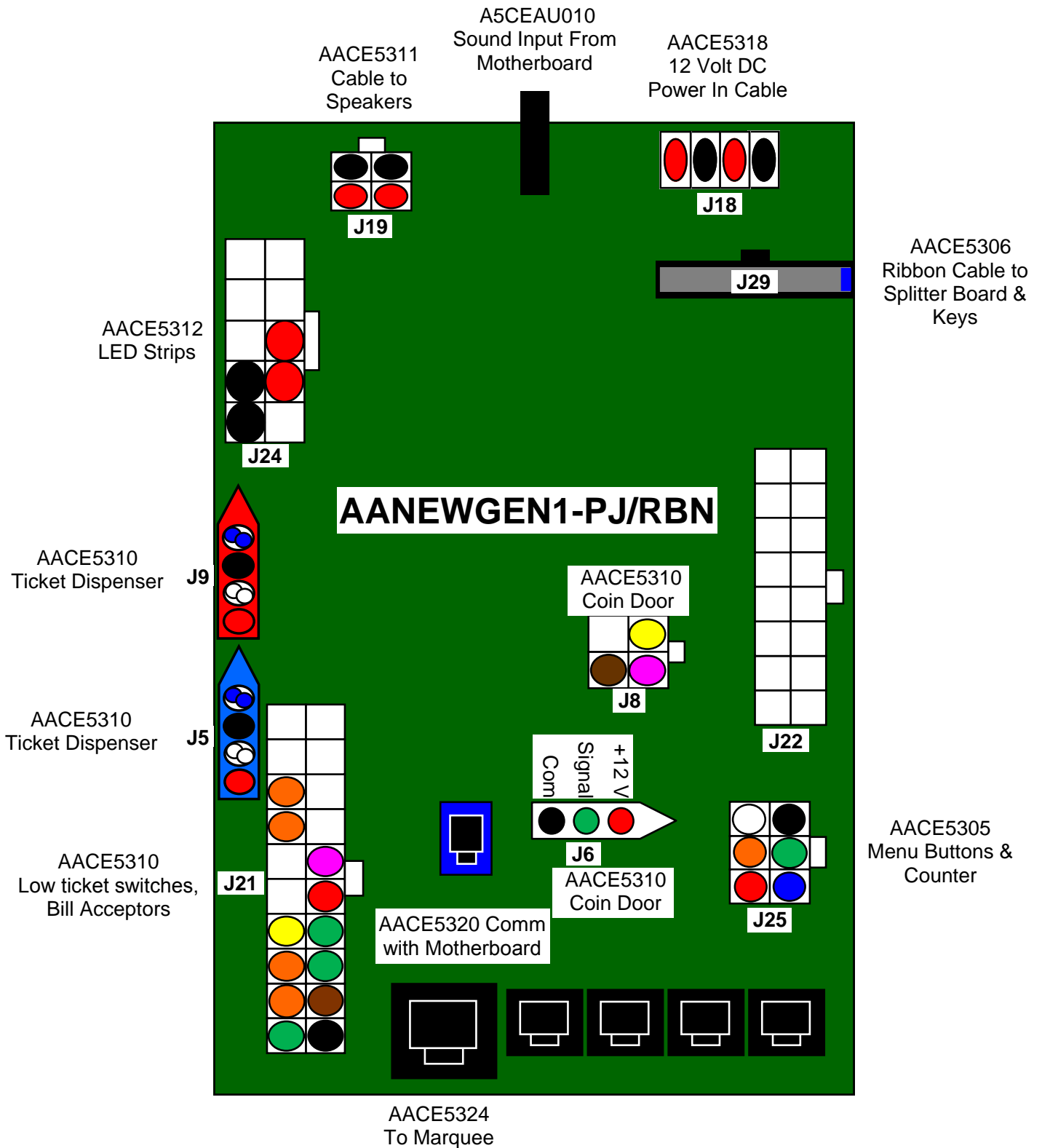

WIRING DIAGRAMS

COIN MECHS, TICKET DISPENSERS, DBAS, LOW TICKET SWITCHES

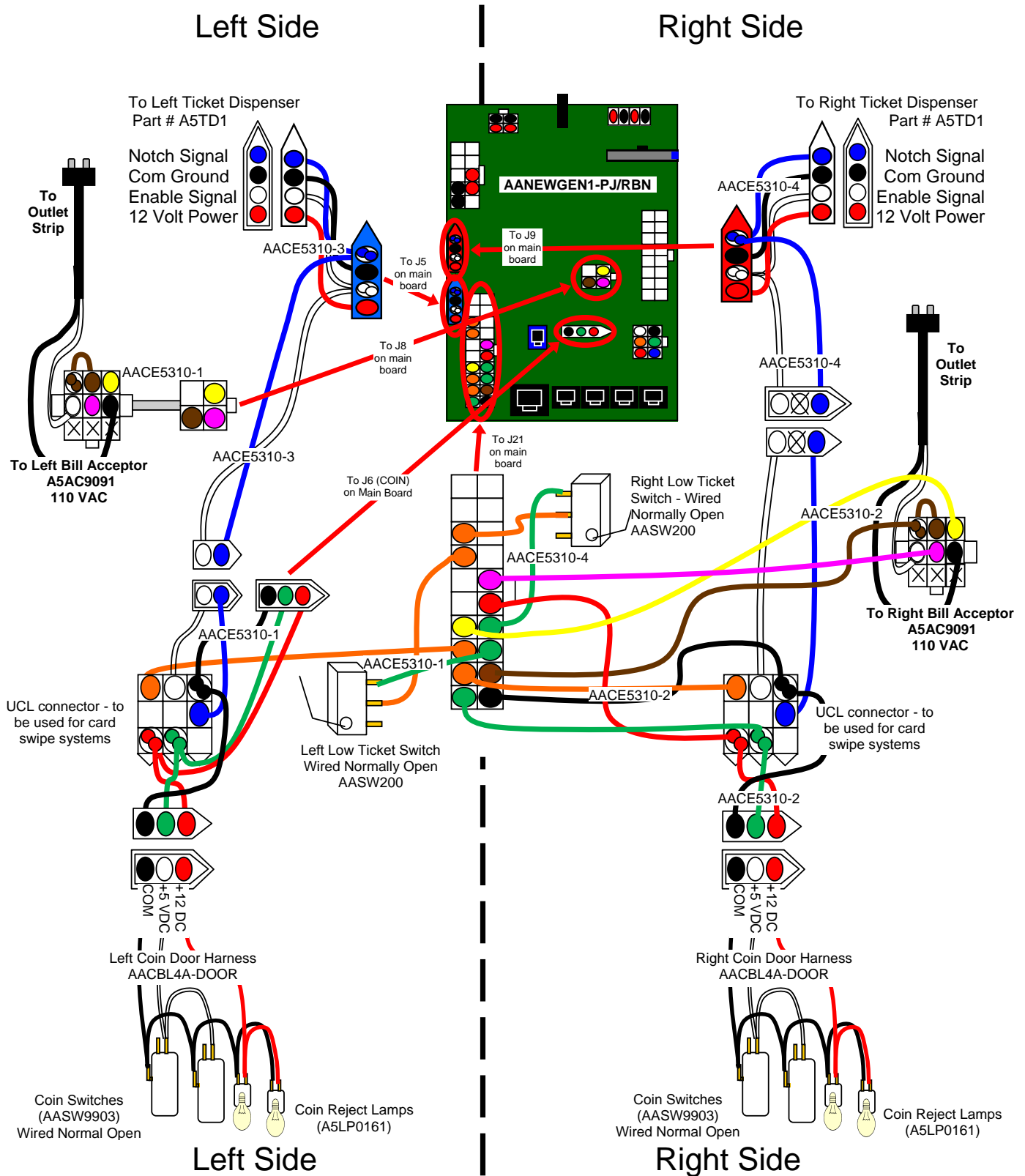

WIRING DIAGRAMS

MENU BUTTONS, SPEAKERS, METERS (COUNTERS)

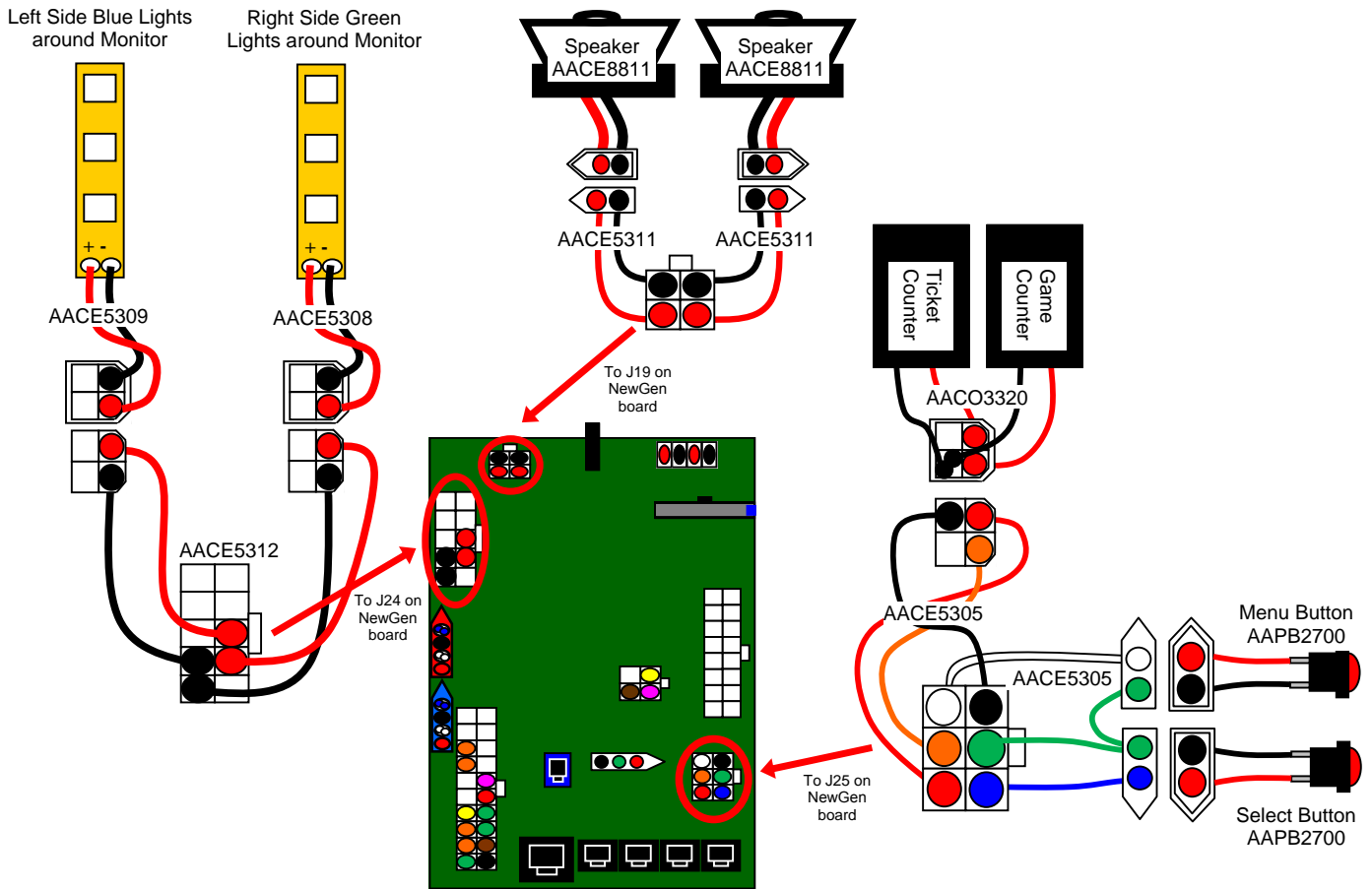

WIRING DIAGRAMS

PIANO KEYS

Blue LED Under Keys
AACE5330

Green LED Under Keys
AACE5329

Left Side Piano Keys
For sets of components
populate circuit board per
this example

Right Side Piano Keys
For sets of components
populate circuit board per
this example

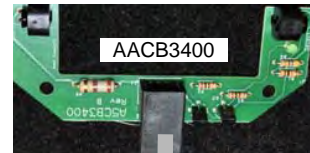
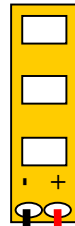
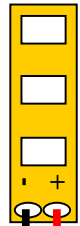

Normally Blocked - so LED is ON
Once key is pressed, Sensor is not
blocked, so LED is OFF

Normally Blocked - so LED is ON
Once key is pressed, Sensor is not
blocked, so LED is OFF

A5CE5313

A5CE5313

Piano Keys Interface Board

Piano Keys Interface Board

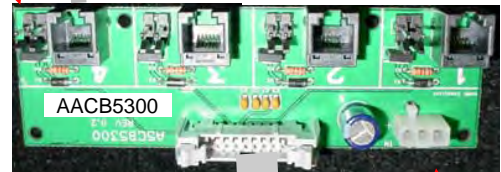
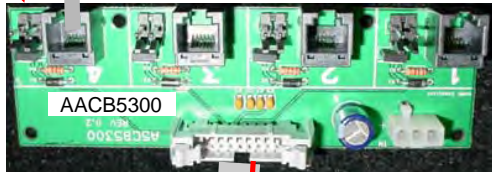

AACE5307

AACE5307

Communication
to Left Side

Communication
to Right Side



12 VDC
Power In



AACE5306

Communication from
NewGen

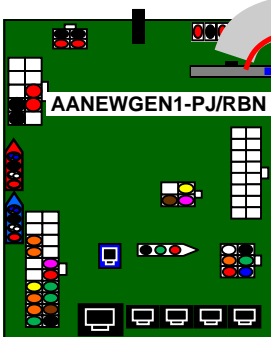

WIRING DIAGRAMS

MARQUEE

There are 2 different bubble marquee lighting schemes that depend on your game serial number.

Original Design:

Game serial #'s:
All prototype games and up to 113, 117, 127 - 130

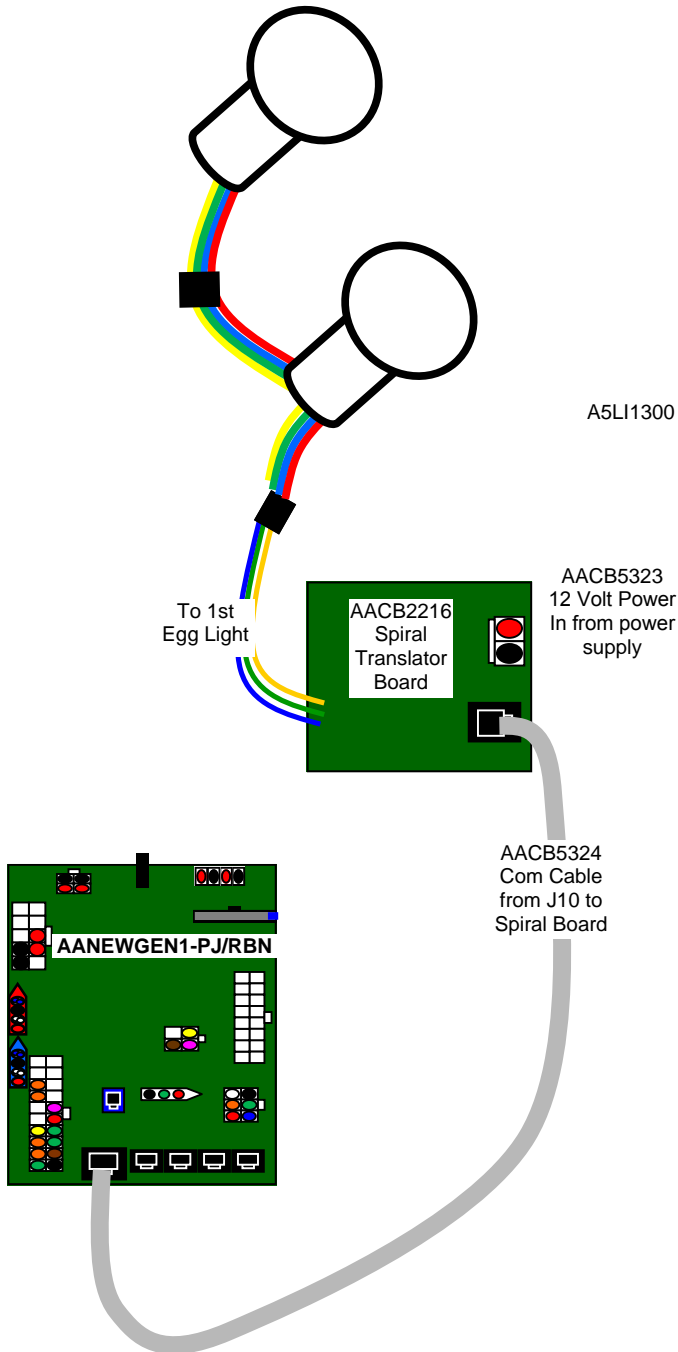

Current Design:

Game serial #'s:
114 - 116, 118 - 126
131 and higher

Marquee Lights are
connected together
around perimeter of
marquee.
28 Total

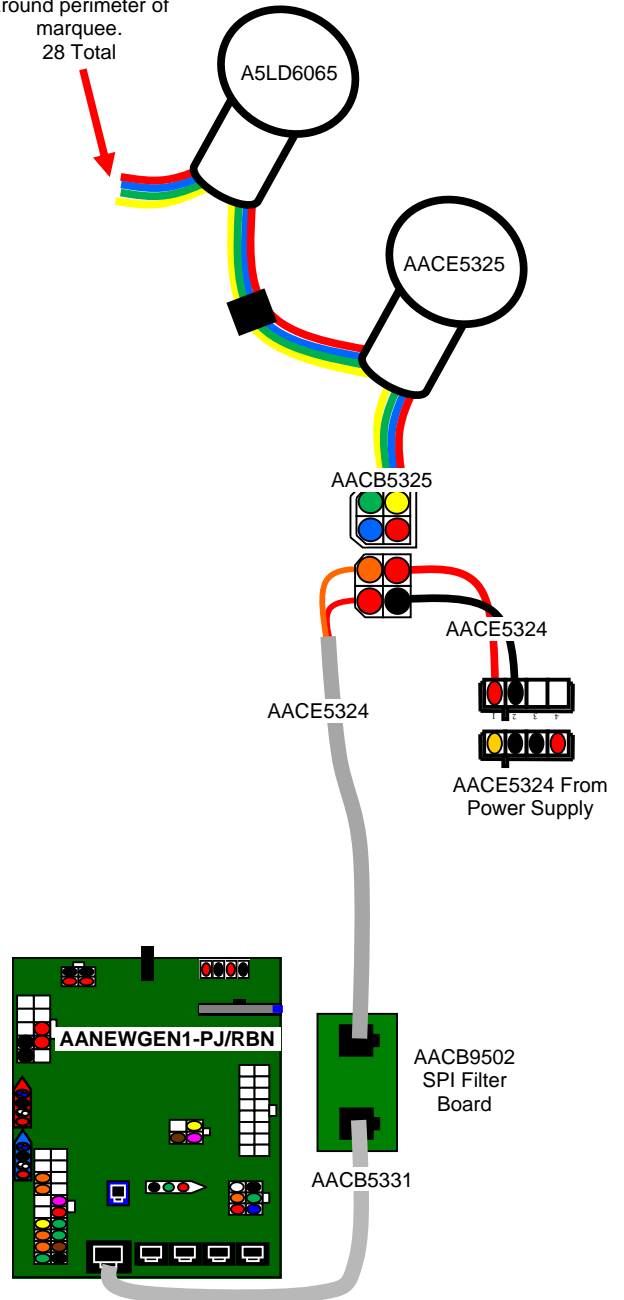

WIRING DIAGRAMS

MOTHERBOARD COMMUNICATION

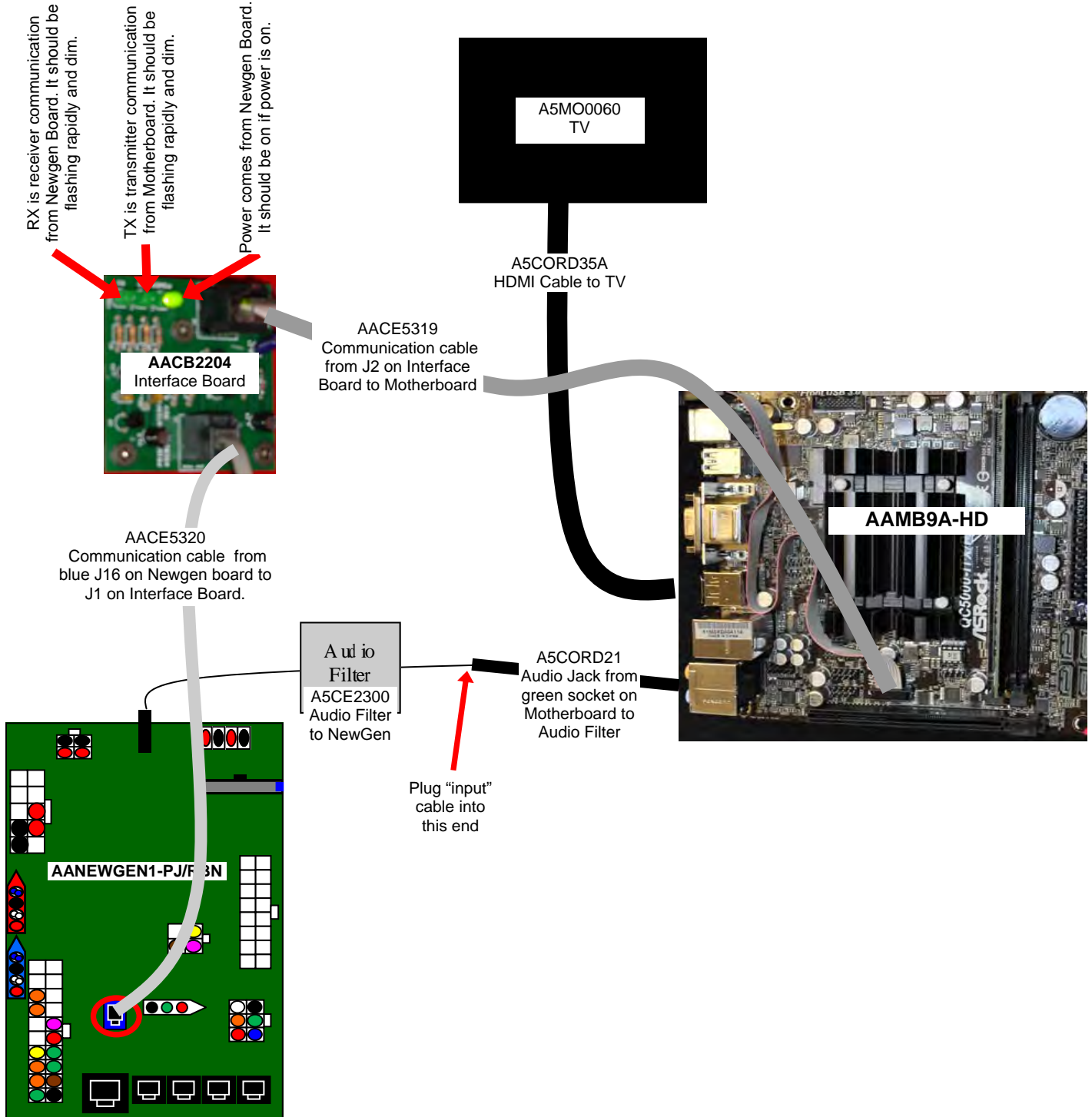

WIRING DIAGRAMS

AC IN & POWER SUPPLY

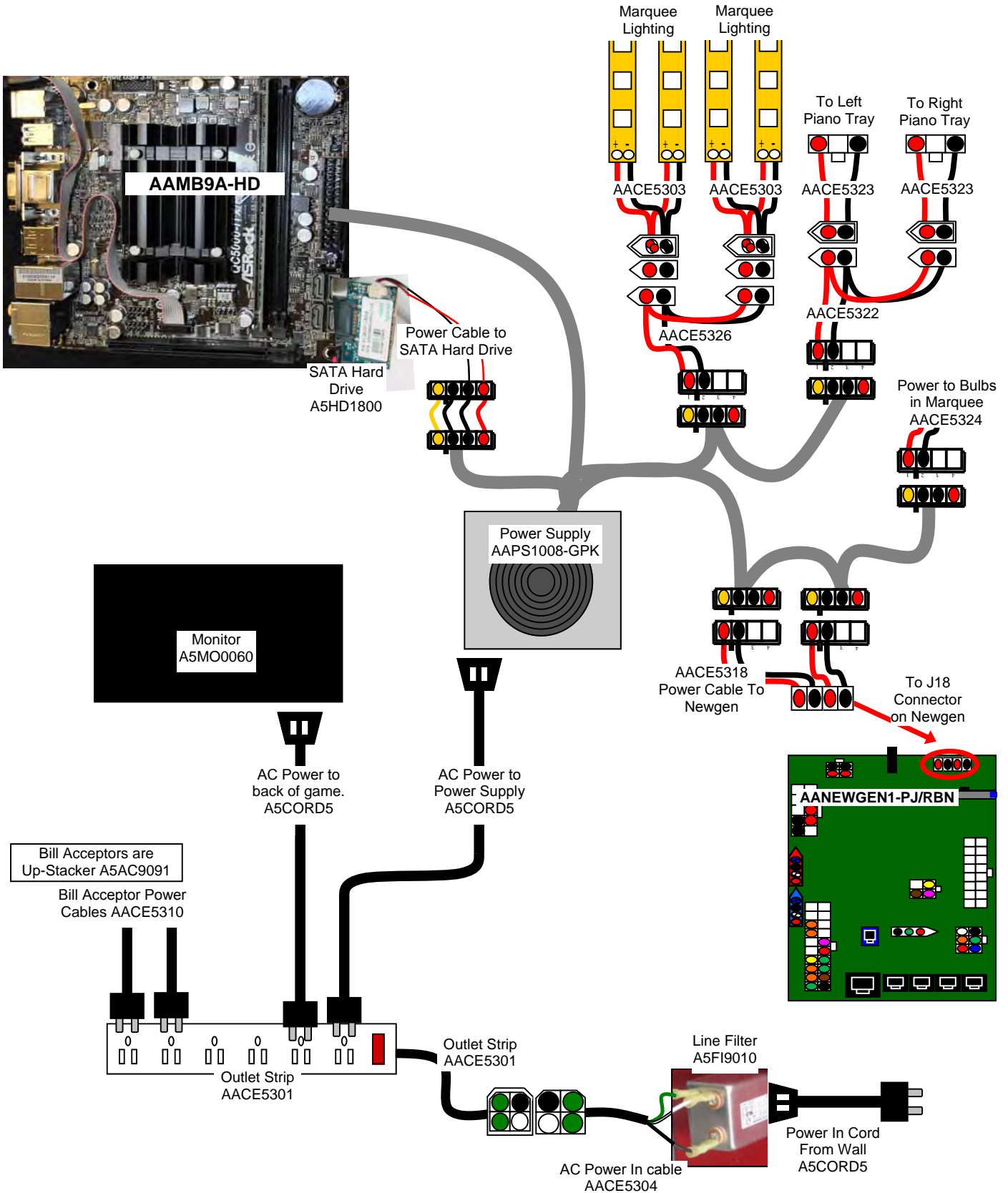

TROUBLESHOOTING GUIDE

Troubleshooting Strategy

Use common sense and a systematic method of troubleshooting to determine the exact problem, probable cause and remedy. Use the process of elimination to find the faulty component. Always check for the simple and obvious causes first such as unplugged, loose or broken wires and bad sensors, bent, pinched, stuck or jammed components.

| Troubleshooting Chart | | |
|---|--|---|
| Problem | Probable Cause | Remedy |
| <p>No power to the game. No lights on at all.</p> | <p>Unplugged. Circuit breaker tripped. Line Filter Faulty. Power strip faulty. Faulty cable/power supply.</p> | <p>Check wall outlet. Reset power strip breaker switch or building circuit breaker. Replace Line Filter (Part # A5FI9010) Change plug position, replace if needed. See Motherboard Power Supply diagnostics</p> |
| <p>Bill Acceptor on. But everything else off. (Power Supply not ON)</p> | <p>Power supply unplugged. Rocker Switch. Power supply shutting down because of 12 V overload. Faulty power supply.</p> | <p>Insure unit is plugged into power strip. Make sure rocker switch is set ON.  See power supply diagnostics to isolate bad component. A 12 volt short would cause this. See Motherboard Power Supply diagnostics</p> |
| <p>Dollar Bill Acceptor not functioning.</p> <p>Ensure Bill Acceptor is set to "Always Enable"</p> | <p>Look for "Minigen Comm error" on screen. Check for power to Bill Acceptor. Dirt or debris in acceptor slot. Pinched, broken, or disconnected wiring. Bill acceptor problem. Part # A5AC9091</p> | <p>Refer to "Minigen Comm error" diagnostic section. Acceptor should cycle stacker at game power up. If not, check cable connections. Refer to "How to Clean Bill Acceptor" Or clean with bill reader cleaning card. (A5CC9000) Check wiring from bill acceptor to NewGen Board. (AACE5310) Repair or replace wiring harness. Check J8 connector on Main Board for left side Bill Acceptor. Check J21 connector on Main Board for right side Bill Acceptor. Make sure wires are secure in connectors. Refer to troubleshooting section of dollar bill acceptor manual included with this game or the diagnostics label of the back of the unit.</p> |
| <p>Meters do not work.</p> <p>Game meter will click as the game starts. If 5 dollars are inserted it will click once, then at the start of next 4 games. Ticket meter will click as tickets come out of game and notch is "seen" by dispenser.</p> | <p>Ensure correct number of tickets are being dispensed. Disconnected, loose or broken wires. Faulty counter.</p> | <p>Check ticket values. Refer to Tickets not dispensing troubleshooting section. Check connections and reseal J25 on Newgen board. Cables # AACE5305 and AACO3320 Replace counter. AACO3320</p> |



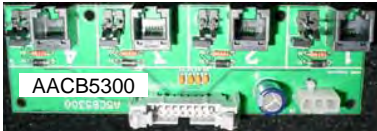
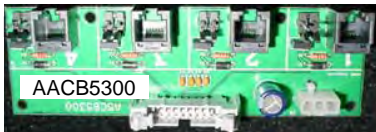

TROUBLESHOOTING GUIDE

| Problem | Probable Cause | Remedy |
|--|--|--|
| <p>Menu Buttons do not work</p> <p>Press and hold for 5 seconds.</p> | <p>Is “MiniGen Comm Err” on screen?</p> <p>Disconnected, loose or broken wires.</p> <p>Faulty push button</p> | <p>Check ticket values. Refer to “MiniGen Comm Error” troubleshooting section.</p> <p>Check connections and reseat J25 on Newgen board. Cables # AACE5305 and AAPB2700</p> <p>Replace pushbutton. Part # AAPB2700</p> |
| <p>Left (Blue) or Right (Green) Lights around Monitor do not light.</p> | <p>Disconnected, loose or broken wires.</p> <p>Check for 12 Volts to LED’s</p> | <p>Check connections and reseat J24 on Newgen board. Cables # AACE5312, AACE5309 (Left) and AACE5308 (Right)</p> <p>If no 12 VDC, replace NewGen Board</p> |
| <p>Some Marquee Light Bulbs do not operate correctly.</p> | <p>One Marquee Bulb is faulty and causing others down the line to malfunction.</p> <p>Disconnected, loose or broken wires.</p> <p>Faulty Marquee Bulb</p> | <p>Remove faulty bulb and plug in next one in line to verify. Replace Bulb. A5LD6065.</p> <p>Check connections in between bulbs for broken or loose wires.</p> <p>Replace Marquee Bulb: The first bulb is part # AACE5325, all the others are part # A5LD6065.</p> |
| <p>All Marquee Light Bulbs do not operate correctly.</p> | <p>Power In cable from power supply is disconnected, loose or has broken wires.</p> <p>Communication cable from NewGen is disconnected, loose or has broken wires.</p> | <p>Check cable # AACE5324</p> <p>Check cable # AACE5324, AACE5331, and SPI filter board part # AACB9502</p> |
| <p>LED illumination in Marquee is not on.</p> | <p>Power In cable from power supply is disconnected, loose or has broken wires.</p> <p>LED Strip faulty.</p> | <p>Check connection to power supply. Cables # AACE5326 and AACE5303</p> <p>Replace LED strip. Part # AACE5303</p> |

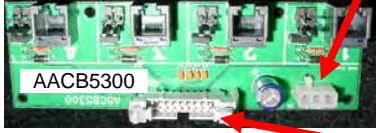

TROUBLESHOOTING GUIDE

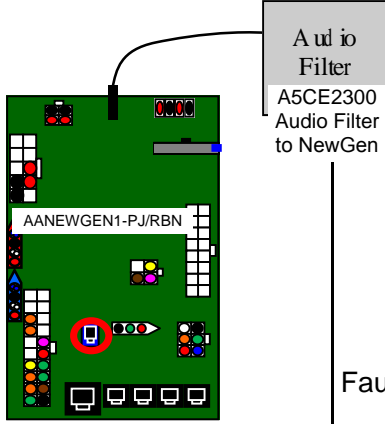
| Problem | Probable Cause | Remedy |
|---|---|---|
| <p>Scoring Incorrectly</p>  | <p>Each key pressed is sensed by a metal tab on the back of key breaking an opto sensor.</p> <p>Refer to sections below to identify specific scoring problem.</p> | <p>Sensor is normally blocked, and LED indicator on board is ON.</p> <p>When key is pressed, sensor becomes unblocked and LED is OFF.</p> |
| <p>One key does not score</p> <p>Sensor is faulty behind key.</p> | <p>Remove piano tray to inspect sensor.</p> <p>Opto dirty or misaligned.</p> <p>Faulty cable.</p> <p>Faulty sensor.</p>  | <p>Refer to “How to access Piano Keys and Sensor” section.</p> <p>Clean optos and re-align optos.</p> <p>Inspect and reseal cable, swap with working key’s cable.</p> <p>Plug non-working sensor and cable into different socket on the Piano Keys Interface Board.</p> <p>If problem follows sensor - replace sensor (AACB3400)</p> <p>If problem stays with socket - replace Interface Board (AACB5300)</p> |
| <p>One key is scoring by itself or double scoring</p> <p>Sensor behind key is weak or misaligned.</p> | <p>Remove piano tray to inspect sensor.</p> <p>Opto dirty or misaligned.</p> <p>Faulty cable.</p>  | <p>Refer to “How to access Piano Keys and Sensor” section.</p> <p>Clean optos and re-align optos.</p> <p>Inspect and reseal cable, swap with working key’s cable.</p> <p>Plug non-working sensor and cable into different socket on the Piano Keys Interface Board.</p> <p>If problem follows sensor - replace sensor (AACB3400)</p> <p>If problem stays with socket - replace Interface Board (AACB5300)</p> |
| <p>Game not coining up.</p> | <p>Look for “Minigen Comm err” on screen.</p> <p>Ensure game makes sound when coin switch is triggered.</p> <p>Game set to large amount of credits per game.</p> | <p>Refer to “MiniGen Comm Err” error diagnostic section.</p> <p>Check coin switches—both should be wired normally open. If one switch is “closed” the other will not work either.</p> <p>Check wiring to NewGen Board. (AACBL4A-DOOR, AACE5310)</p> <p>Check Pay In/Out Menu. Ensure Coins/ Credits per Game is set. Default = 4.</p> |

TROUBLESHOOTING GUIDE

| Problem | Probable Cause | Remedy |
|--|--|--|
| <p>Entire side of keys do not score</p> <p>Interface Board faulty or disconnected</p>  | <p>Check for 12 Volts DC power into Interface board.</p>  <p>Check ribbon cable to Splitter Board</p> | <p>Check cable # AACE5323 for 12 volts DC Follow back to power supply and ensure good connection.</p> <p>Plug ribbon cable into a different socket on the Splitter Board. If problem follows ribbon cable - replace Interface Board (AACB5300) If problem stays with socket - replace Splitter Board (AACB5300), ribbon cable to NewGen (AACE5306) or NewGen (AANEWGEN1-PJ/RBN)</p> |
| <p>Both sides of keys do not score</p> <p>Ribbon cable or NewGen Board faulty</p>  | <p>Check for 12 Volts DC power into both Interface boards.</p> <p>Check ribbon cable from Splitter Board to NewGen Board</p> | <p>Check cables # AACE5323 for 12 volts DC Follow back to power supply and ensure good connection.</p> <p>Reseat ribbon cable on both ends. If problem persists - replace Splitter Board (AACB5300), ribbon cable to NewGen (AACE5306) and NewGen (AANEWGEN1-PJ/RBN)</p> |
| <p>No Sound</p> <p>Motherboard creates sound, NewGen board amplifies it.</p>  | <p>Volume set to zero in menu.</p> <p>Disconnected, loose or broken wires.</p> <p>Faulty speaker.</p> | <p>Enter Main Menu and verify: Game Volume & Attract Volume are not zero</p> <p>Check connections and reseat audio cable from motherboard to NewGen board. Cables # AACE8811, AACE5311, and A5CE2300, A5CORD21.</p> <p>Unplug audio jack cable (A5CORD21) from motherboard, plug into MP3 player and see if music is amplified and comes out of speaker. If Yes - then motherboard is faulty. If No - then NewGen may be faulty.</p>  <p>Determine if NewGen board is good.</p> <p>Replace speaker. AACE8811</p> |

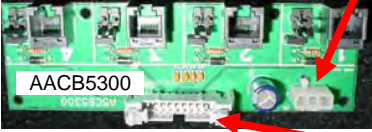
TROUBLESHOOTING GUIDE

| Problem | Probable Cause | Remedy |
|--|---|---|
| <p>One key does not light up</p> <p>LED strip is faulty behind key.</p> | <p>Remove piano tray to inspect sensor.</p> <p>LED strip unplugged from CB5300 board.</p> <p>Faulty cable.</p> | <p>Refer to “How to access Piano Keys and Sensor” section.</p> <p>Inspect and reseat cable, swap with working key’s cable.</p> <p>Plug non-working LED cable into different socket on the Piano Keys Interface Board.</p> <p>If problem follows LED - replace LED (AAACE5330)</p> <p>If problem stays with socket - replace Interface Board (AACB5300)</p> |
| <p>Entire side of keys do not light up</p> <p>Interface Board faulty or disconnected</p>  | <p>Check for 12 Volts DC power into Interface board.</p>  <p>Check ribbon cable to Splitter Board</p> | <p>Check cable # AAACE5323 for 12 volts DC Follow back to power supply and ensure good connection.</p> <p>Plug ribbon cable into a different socket on the Splitter Board.</p> <p>If problem follows ribbon cable - replace Interface Board (AACB5300)</p> <p>If problem stays with socket - replace Splitter Board (AACB5300), ribbon cable to NewGen (AAACE5306) or NewGen (AANEWGEN1-PJ/RBN)</p> |
| <p>Both sides of keys do not light up</p> <p>Ribbon cable or NewGen Board faulty</p>  | <p>Check for 12 Volts DC power into both Interface boards.</p> <p>Check ribbon cable from Splitter Board to NewGen Board</p> | <p>Check cables # AAACE5323 for 12 volts DC Follow back to power supply and ensure good connection.</p> <p>Reseat ribbon cable on both ends.</p> <p>If problem persists - replace Splitter Board (AACB5300), ribbon cable to NewGen (AAACE5306) and NewGen (AANEWGEN1-PJ/RBN)</p> |
| <p>Low Tickets message on monitor</p> | <p>Tickets are empty in ticket tray</p> <p>Faulty cable. Disconnected, loose or broken wires.</p> <p>Faulty low ticket switch.</p> <p>Faulty NewGen Board</p> | <p>Load tickets into tray. Ensure tickets hold down micro switch wire.</p> <p>Check connectors from low ticket switches to NewGen board. Check for continuity. (AAACE5310)</p> <p>Inspect switch and replace if needed. (AASW200)</p> <p>Replace NewGen Board. (AANEWGEN1-PJ/RBN)</p> |

TROUBLESHOOTING GUIDE

| Problem | | Probable Cause | Remedy |
|---|--|---|--|
| Tickets do not dispense or Wrong amount dispensed. Check for the correct amount of tickets showing on monitor | Tickets on monitor does not match tickets coming out of game. | Opto Sensor on ticket dispenser dirty. Faulty ticket dispenser. Notch on tickets cut too shallow. Faulty cable. Disconnected, loose or broken wires. | Blow dust from sensor and clean with isopropyl alcohol. Replace with working dispenser to isolate the problem. (A5TD1) Flip tickets and load upside-down to have large cut notch toward opto sensor. Check connectors from ticket dispensers to NewGen board. Check for continuity. Cables AACE5310 Replace NewGen board(AANEWGEN1-PJ/RBN) |
| | Tickets on monitor does match tickets coming out of game. | Settings in Menu are incorrect. | Enter Menu and check certain areas: Payout Pattern Divide By 2 Fixed Ticket Payout Ticket Cap |

MiniGen Comm Error

MINIGEN COMM ERR

RX is receiver communication from Newgen Board. It should be flashing rapidly and dim.

TX is transmitter communication from Motherboard. It should be flashing rapidly and dim.

Power comes from Newgen Board. It should be on if power is on.



Game does not coin up and error shows on screen

If “Power” is not solid ON
 Ensure AACE5320 cable is plugged into blue “IN” socket on NewGen board. (J16)
 Check AACE5318 cable providing 12 VDC power in to NewGen
 Replace NewGen if needed.
 Replace Serial Interface board. (AACB2204)

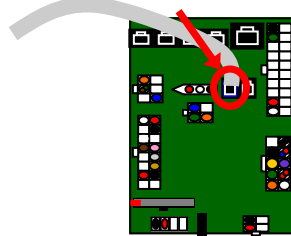

If “TX” & “RX” are not blinking very fast
 Communication to Motherboard faulty.

Check AACE5319 to motherboard.
 Machine may have an adaptor (A5CN1031)

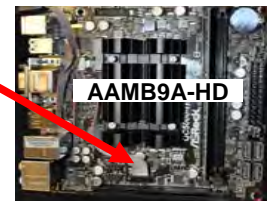

If “TX” is slowly blinking

Motherboard is trying to communicate, but getting no response from the NewGen
 Check cable to NewGen, replace if needed.

If “RX” is solid on.



NewGen is sending bad signals to com board.
 Replace NewGen Part # AANEWGEN1-PJ/RBN

MONITOR TROUBLESHOOTING (LG BRAND)

The monitor on Grand Piano Keys is actually a television.

This has many advantages over a traditional game monitor.

- The TV should power on when game power is applied.
- The TV has a RF sensor (used for remote control) which may be interfered with from other devices.
- The TV uses a HDMI cable from motherboard for video input.

| Problem | Probable Cause | Remedy |
|--|---|--|
| Monitor has nothing at all on power up. | Power cable unplugged from monitor. Monitor turned Off. | Ensure power is plugged into back of monitor, down to power strip. Use remote control or buttons on back of monitor to turn it On. |
| Error on screen at power up. Re-Boot game to see if problem still exists. | Display shows "Kernel panic – unable to mount root" Display shows "ASROCK Setup Utility Menu"  Display shows "Ubuntu— Check drive for errors" | Faulty or loose RAM, faulty software, faulty motherboard No SATA drive in motherboard. Check for red & black power connector from power supply.   Plug in keyboard and press the "F" key. It will check drive for errors and start game |



| | |
|---|--|
| Monitor shows "NO SIGNAL" bouncing around screen. | Monitor HDMI cable unplugged. Power Supply not turning on - Turn game off from wall and wait 5 minutes before turning back On. Important: If power supply itself is turned off inside cabinet, the motherboard is still receiving power from the TV through the HDMI cable. It will not power on correctly until entire game is turned off for 5 minutes. Continue to "Monitor & Power Supply Diagnostics" |
|---|--|

To remove power to game, please either unplug game from the wall, or turn off rocker switch on outlet strip inside game.

Important: If power supply itself is turned off inside cabinet, the motherboard is still receiving power from the TV through the HDMI cable. It will not power on correctly until entire game is turned off for 3 minutes.

How to turn off game:

Open left player door and locate power strip. Switch rocker switch Off.



| | |
|---------------------------------------|---|
| Other Monitor problems | Open back door of cabinet. Menu buttons are located on right edge of monitor. Use buttons to access monitor menu. |
| Blurry Monitor Too bright, or dim. | Verify that the screen looks good and image is centered. Refer to "How to Set up Monitor" Section |



HOW TO: RESET LG MONITOR

If monitor settings are changed by accident, you can reset monitor back to factory defaults, then refer to “How to set up Monitor” to program to settings needed for game operation.

Using buttons on right rear of monitor or remote control, enter the “Option” menu.

Scroll down to highlight “Initial Setting”

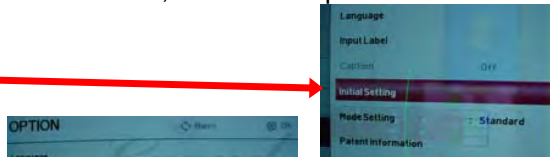

Warning pop up will appear. Select “Yes”

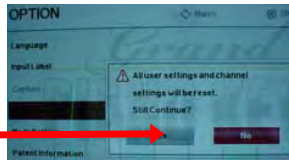

Continue to “How to set up Monitor” to program to settings needed for game operation.



HOW TO: SET UP LG MONITOR

If new monitor is installed, or monitor is reset, the following sequence is to be used to allow game program to be displayed on screen.

Use remote control for easier navigation.

The buttons on the right rear of monitor may also be used.

Select “Next” on initial “Welcome” screen and on English on “Language” screen.

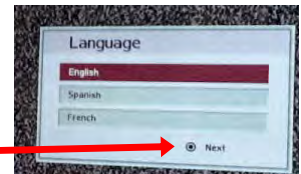

Select “Next” on “Home Use” in Mode Setting screen.

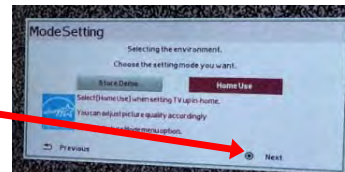

Select “Next” on “Auto” in Time Setting screen.

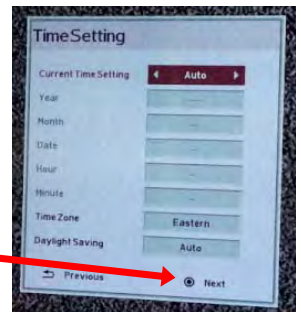

Select “Next” in Auto Tuning screen.

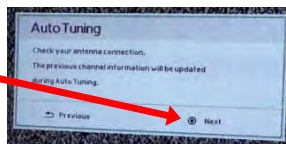

Select “Close” on Channel screen.

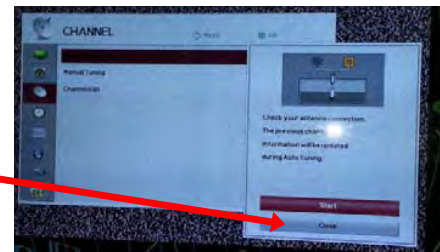

Scroll down left side of screen to “Inputs”



Select “HDMI1”



The screen will now show the Grand Piano Keys program.

HOW TO: ACCESS PIANO KEYS & SENSORS

Entire tray with 4 keys can be slid out toward front of game to access sensors and LED's.

To Remove Tray:

Open front door and remove 2 bolts with 7/16" wrench.

Carefully slide tray out toward front of cabinet.

Sensors are now visible to further troubleshoot.

Sensors:

Are Normally Blocked - so LED is ON

Once key is pressed, Sensor is not blocked, so LED is OFF

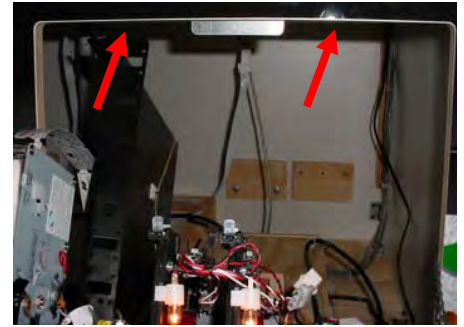

HOW TO: INSTALL/UPDATE SOFTWARE

There are 2 boards into which software can be installed:

1.) Newgen Software Installation - With game power ON - insert USB update stick into Minigen socket on right edge of board. Press "Boot" button on Minigen located near dipswitches.



2.) Motherboard Software Installation - To remove power to game, please either unplug game from the wall, or turn off rocker switch on outlet strip inside game.

Important: If power supply itself is turned off inside cabinet, the motherboard is still receiving power from the TV through the HDMI cable. It will not power on correctly until entire game is turned off for 3 minutes.

How to turn off game:

Open left player door and locate power strip. Switch rocker switch Off.

Remove old SATA drive located in bottom left corner of motherboard. Install new SATA software.

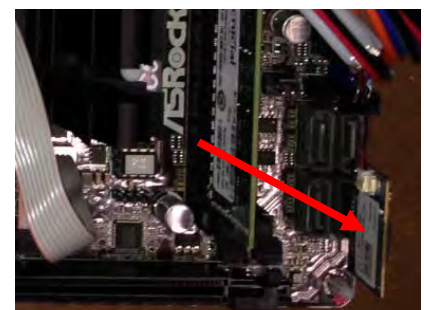

MOTHERBOARD & POWER SUPPLY DIAGNOSTICS

1.) Verify AC power to game. Check power strip in front door.

The rocker switch should be illuminated.



2.) Check connection to power supply.

3.) Ensure Power Supply switch is set to 115V (or 230V)
(Some model power supplies may not have this)

4.) Ensure Power switch is on.

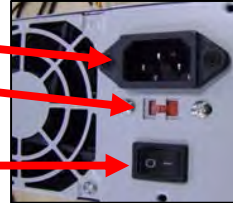

5.) Ensure fan is turning.

- If power supply fan is turning and there is no 12 Volt out, then replace power supply. (A5PS1008)
- If power supply fan is not turning, then continue to "Verify Power to Motherboard"

Important: If power supply itself is turned off inside cabinet, the motherboard is still receiving power from the TV through the HDMI cable because monitor is running from 110VAC and feeding the motherboard.

It will not power on correctly until entire game is turned off for 5 minutes.

Verify Power to Motherboard

The motherboard will turn on power supply.

If your game has no 12 volts, it may be the motherboard not turning on.

There may be a 12 volt short somewhere else in cabinet that is not allowing the power supply to turn on.

Minimize load on power supply and isolate short

Unplug all outputs from power supply except for motherboard.

This will have power supply, motherboard, and monitor left plugged in.

If power supply, motherboard, and monitor now turn on:

Plug in one component at a time to power supply to locate short.

**If power supply still does not power on, unplug entire game from wall and wait a full 5 minutes.
Then plug game back in to wall.**

If power supply still does not power on, replace power supply (AAPS1008-GPK)

Replace motherboard if still does not power on. (AAMB9-HD)

BILL ACCEPTOR DIAGNOSTICS

Note: There are many different models and brands of Bill Acceptors that are used on redemption games. Your Bill Acceptor may differ from the unit shown.

Standard DBA is MEI # AE-2451-U5E/120v Part # A5AC9091

If you need an adapter plate, it is part # A5PL4200

Determine if Bill Acceptor has power:

Turn game ON—The bill acceptor should make noise as stacker cycles and green lights on outside bezel should flash.

If NO power:

Use meter to measure 110 AC voltage at cable going into Bill Acceptor from power strip.

If power is OK:

Clean Bill Acceptor path to make sure there is nothing jamming unit.

Check dipswitch settings on side of acceptor.

Make sure switch # 8 is OFF for Always Enable

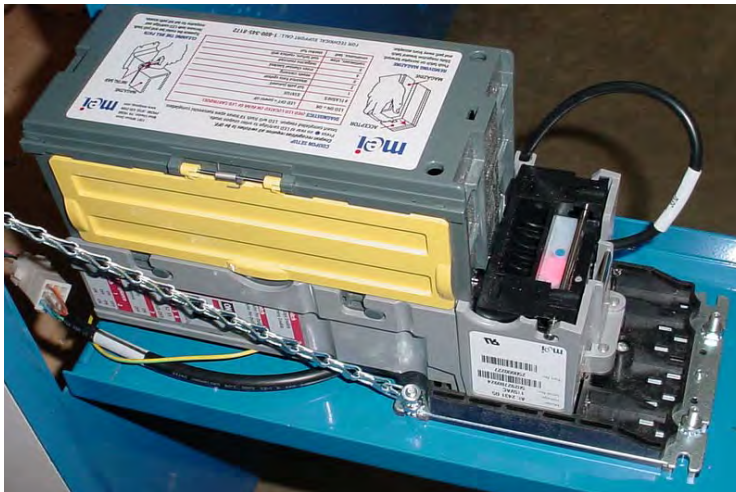
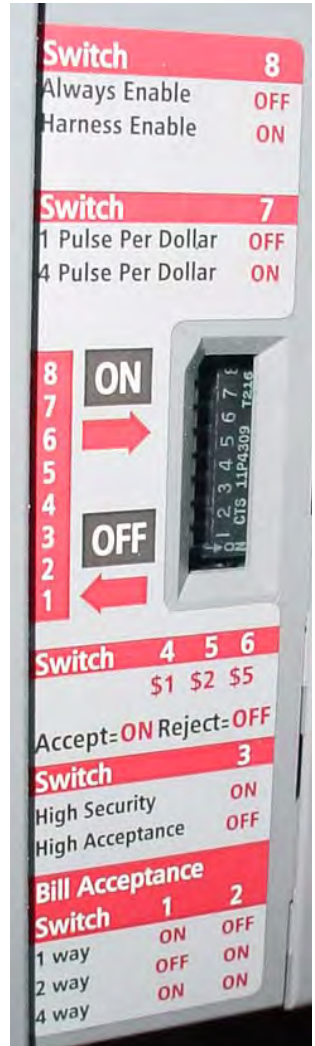

ERROR CODES

Count the number of flashes on front bezel of Bill Acceptor and follow chart for repair.

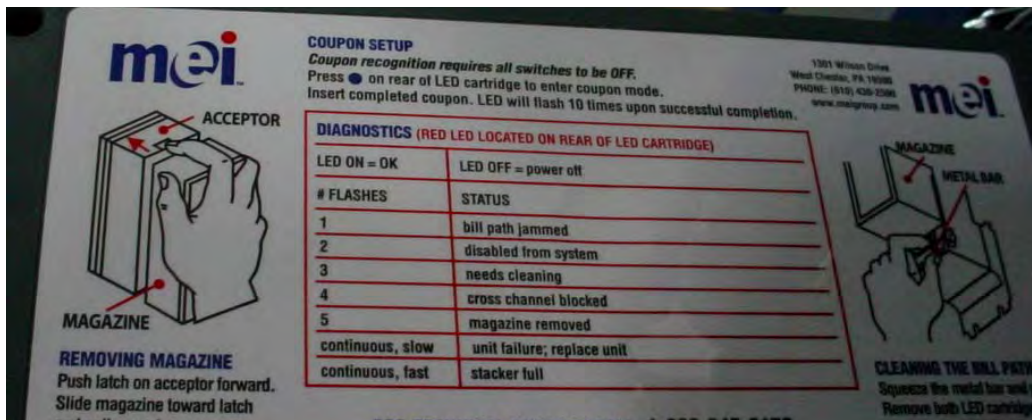

DEBIT CARD SYSTEM SETUP

The Grand Piano game is pre-wired with a UCL (Universal Card Link) connector to accept Card Swipe systems from many different manufacturers.

Please follow these instructions to make full use of Grand Piano Keys capabilities.

Option #1:

Card swipe systems may come with a standard 9 pin Molex connector.
This is the UCL connector.

Simply plug this connector into your card swipe reader.

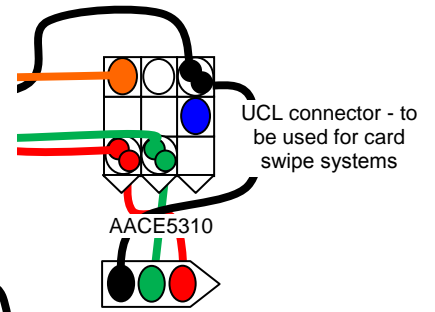

Option #2:

If your card swipe systems does not have a standard 9 pin Molex connector, then you will have to splice wires into the AACE5310 harness.

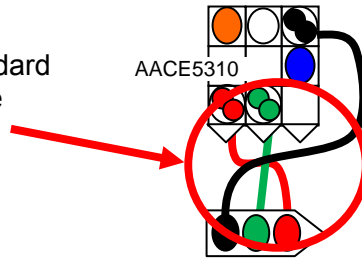

Menu Changes

- Enter menu, go to "Pay In/Out" Menu
- Change "Credits" to 1
- Change "Card Reader" to Enabled

- Go to "Game Settings" Menu
- Set "Payout Type" to either Tickets, coupons

Special Note for **Embed** - Set Game Drive Threshold = 2 Volts

Additional:

Baytek sells an optional sticker sheet that will cover up the "Insert Coin" on many different types of games.
Part # A5DE0047

Example: Stick on Big Bass Wheel to cover "Insert Coin" artwork.

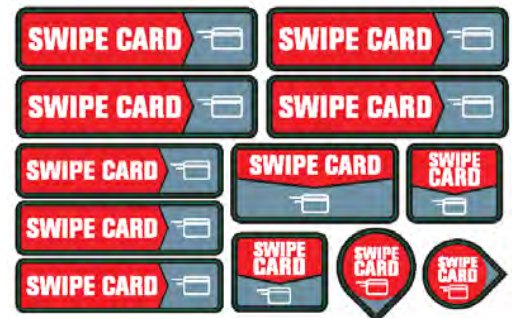

PARTS LIST

| PART # | DESCRIPTION | PART # | DESCRIPTION |
|-----------|---|------------------|--|
| A5CB9200 | Cash Box | AACE5326 | Power Supply to Marquee Light Bars |
| A5SW200 | Low ticket Switch | AACE5329 | Left Green Piano Key Lights |
| A5FI9010 | Inline Filter | AACE5330 | Right Blue Piano Key Lights |
| W5TM1316 | 13/16" Blk/Silver T-Molding | AACE8811 | Speaker Assembly |
| W5TM4001 | 13/16" White T-Molding | AAPB2700 | Push Button Assembly |
| A5CN1031 | Monitor Connector Adapter | AABENCH-GPK | Bench Assembly |
| A5LK2001 | Cash Box A05/E00 Key Code | AAPS1008-GPK | Power Supply |
| A5LK5002 | 7/8" H95 Key Code (644) | AASIGN-GPK | Marquee Sign Assembly |
| A5LD6065 | LED Lights Around Marquee (27 Per) | A5TD1 | Ticket Dispenser |
| AACO3320 | Counters | A5DE0042 | New Menu/Volume Pot Decal |
| A5BK1013 | Push Button/Counter Bracket | A5DE5300 | Artwork Around Monitor |
| A5TT4000 | Ticket Tray | A5DE5301 | Instructions Decal |
| A5RO5300 | 3/4" Rod | A5DE5302 | Front Cabinet Decal |
| A5PL4200 | Upstacker Bill Acceptor Plate | A5DE5302-1 | Service Door Decal |
| A5PL8900 | Bill Validator Blanking Plate | A5DE5302-2 | Left Coin Mech Door Decal |
| A5ME5300 | Metal Front Keyboard | A5DE5302-3 | Right Coin Mech Door Decal |
| A5ME5301 | Metal Keyboard Flag | A5DE5302-4 | Left Cashbox Door Decal |
| A5ME5302 | Metal Cabinet Rail (Below Serial # 115) | A5DE5302-5 | Right Cashbox Door Decal |
| A5ME5304 | Metal Cabinet Rail (Serial # 115 & Up) | A5DE5303 | Top Left Side Piano Body Decal (< S/N115) |
| A5ME5303 | Metal Bench Rail | A5DE5313 | Top Left Side Piano Body Decal (> S/N115) |
| A5CORD35A | 10' HDMI Cable | A5DE5304 | Back Bay Tek Bench Decal |
| A5CORD5 | AC Computer Cord | A5DE5305 | Bottom Side "Grand Piano" Decal (< S/N115) |
| A5CEAU010 | Audio Stereo Cable | A5DE5314 | Bottom Side "Grand Piano" Decal (>S/N115) |
| AACE1710 | Ground Cable | A5DE5306 | Top Right Side Piano Body Decal (< S/N115) |
| AACE5301 | Outlet Strip Cable | A5DE5315 | Top Right Side Piano Body Decal (> S/N115) |
| AACE5303 | Marquee Led Stick Light | A5DE5307 | Ticket Plate Decal (2 Per) |
| AACE5304 | Line Filter Cable | A5DE5308 | Marquee Face Decal |
| AACE5305 | Menu Button/Counter Cable | A5DE5309-1 | Top Frame Marquee Decal |
| AACE5306 | NewGen to Splitter Board Ribbon Cable | A5DE5309-2 | Bottom Frame Marquee Decal |
| AACE5307 | Splitter Board to Player Station Ribbon | A5DE5309-3 | Left Frame Marquee Decal |
| AACE5308 | Green LED Monitor Lights | A5DE5309-4 | Right Frame Marquee Decal |
| AACE5309 | Blue LED Monitor Lights | A5DE5310-1 | Left Back Bench Decal (Blue) |
| AACE5310 | New Gen1 to Left Coin Door & DBA | A5DE5310-2 | Right Back Bench Decal (Green) |
| AACE5311 | Speaker Cable | A5DE5311 | Left Side Bench Decal (Blue) |
| AACE5312 | New Gen1 to Monitor Light Cable | A5DE5312 | Right Side Bench Decal (Green) |
| AACE5313 | Key Drive Board to Key Sensor Cable | WARR0027-GPKP | Front Window |
| AACE5314 | Hinge Ground Wire Cable | A5VF5300 | Piano Keys |
| AACE5315 | Hinge to Ticket Dispenser Ground Wire | A5MO0060 | 60" TV (No Discount Applies) |
| AACE5318 | Power Supply to NewGen1 Cable | AACB2204 | Communication Board |
| AACE5319 | Printer Interface to Main Board Cable | AACB2216 | Marquee Light Board (< S/N115) |
| AACE5320 | Printer Interface to NewGen1 Cable | AACB3400 | Piano Key Sensor (8 Per) |
| AACE5322 | Power Supply to Key Board Power | AACB5300 | Piano Keys Light Board (2 Per) |
| AACE5323 | Key Board Power Jumpers Cable | AACB5301 | Ribbon Cable Splitter Board |
| AACE5324 | NewGen1 to Marquee Cable | AANEWGEN1-PJ/RBN | New Gen1 Main Board |
| AACE5325 | First Marquee Light With Cable | AAMB9A-HD | MB9 Mother Board |
| A5LD6065 | LED Lights Around Marquee (27 Per Game) | | |

PARTS PICTURES

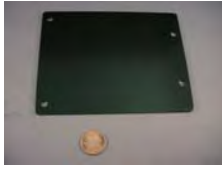

A5PL9097



A5CB9200



A5CA1005

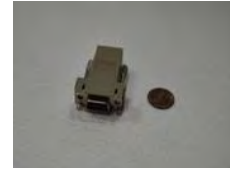

A5CN1031



A5CEAU010



A5CORD5



A5FI9010



A5LK2001



A5LK5001



A5LK5002



A5DE5300



A5DE53001



A5DE5302



A5DE5302-1



A5DE5302-2



A5DE5302-3



A5DE5302-4



A5DE5302-5



A5DE5303



A5DE5304



A5DE5305



A5DE5306



A5DE5307



A5DE5308



A5DE5309-1



A5DE5309-2



A5DE5309-3



A5DE5309-4



A5DE5310-1



A5DE5310-2



A5DE5311



A5DE5312

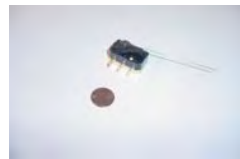

A5SW200



A5TD1



AAPS1008-GPK

PARTS PICTURES



A5DE3114

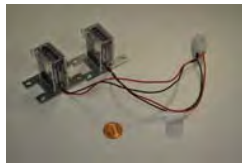

AACO3320



AACBL4A-DOOR



AACE8811



AAAPB2700



AACE1710



AACE5301



AACE5304



AACE5305



AACE5306



AACE5307



AACE5308



AACE5309



AACE5310



AACE5311



AACE5312



AACE5313



AACE5314



AACE5315



AACE5318



AACE5319



AACE5320



AACE5322



AACE5323



AACE5324



AACE5326



AACE5329



AACE5330



W5TM1316



AACB3400



AACB5300



AACB5301



AACB2204



AAMB9-HD



AANEWGEN1-PJ/RBN

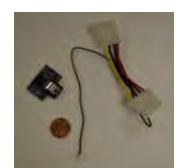

A5HD1800

DECAL IDENTIFICATION



DECAL DIAGRAM

MARQUEE

- A5DE5308_MARQUEE FACE
- A5DE5309-1_MARQUEE FRAME TOP
- A5DE5309-2_MARQUEE FRAME BOTTOM
- A5DE5309-3_MARQUEE FRAME LEFT
- A5DE5309-4_MARQUEE FRAME RIGHT



- A5DE5300_MONITOR SURROUND

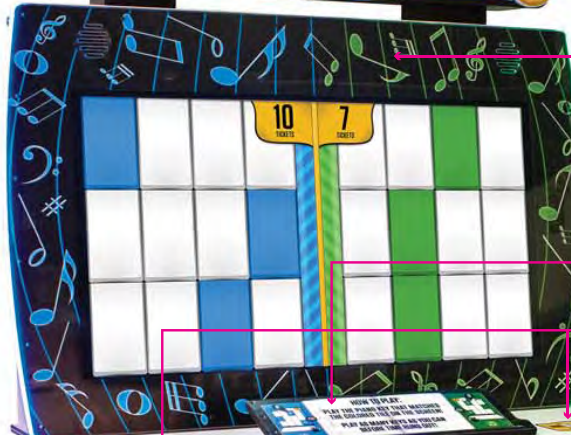

- A5DE5301_INSTRUCTION DECAL
- A5DE5307_TICKET PLATE (2/GAME)

RIGHT SIDE DECALS *(NOT VISIBLE ON DIAGRAM)*

- A5DE5315_PIANO BODY RIGHT
- A5DE5314_CABINET SIDE BOTTOM (2)
- A5DE5312_BENCH SIDE RIGHT

- A5DE5313_PIANO BODY LEFT
- A5DE5314_CABINET SIDE BOTTOM (1/2)

FRONT CABINET DECALS

- A5DE5302_CABINET FRONT
- A5DE5302-1_SERVICE DOOR
(NOT VISIBLE ON DIAGRAM)
- A5DE5302-2_MECH DOOR LEFT
- A5DE5302-3_MECH DOOR RIGHT
- A5DE5302-4_COIN DOOR LEFT
- A5DE5302-5_COIN DOOR RIGHT
(NOT VISIBLE ON DIAGRAM)

- A5DE5311_BENCH SIDE LEFT

- A5DE5310-1_BENCH BACK LEFT
- A5DE5310-2_BENCH BACK RIGHT
- A5DE5304_BENCH SPOT DECAL



TECHNICAL SUPPORT

Excellent customer service is very important to Bay Tek Games!

We know that keeping your games in great operating condition is important to your business. When you need us, we are here to help. You can call us for free technical assistance, and you can count on us to have parts on-hand to support your game. We offer options that fit your needs.

Electronics / Circuit Boards - Repair Options

Repair & Return – If you have Circuit Board issues with your Bay Tek game, you can send the board to us and we'll repair it right away. Most items sent to us are repaired and returned to you within two days. This option is your best value as we offer this fast turn-around service at the most reasonable price.

Advance Replacement – If you have Circuit Board issues with your Bay Tek game, but you don't have time to send in your board in for repair, give us a call and ask for an Advance Replacement. We'll send you a replacement board that same day (pending availability). When you get your new board, just repackage the defective board in the same box and send it back to us. We make it easy by including a UPS Return Shipping label for you to put on the box (not available for international shipments). This is your best option when you need to get your game up and running as quickly as possible!

Spare Parts – Take matters into your own hands and purchase new spare Circuit Boards for your Bay Tek games. Many of our games share the same main-board electronics. This means you can buy one set of spare electronics to support many of your Bay Tek games. Spare boards allow you to get your game up and running the quickest and provide you a valuable troubleshooting option. Call our technicians to get recommendations for what you should keep on hand for spare parts!

Technical Support:

"You" are the best tool for troubleshooting! Your abilities to understand the game and your skills to repair the game are invaluable to us! If you need help, you know you can call us. It's not easy to diagnose a game remotely by phone, but our technicians do a great job. They'll need your help to perform some troubleshooting steps and convey to them exactly what's happening with your game.

Returns, Credits, & Fees:

NOTICE! ALL ITEMS being sent to Bay Tek Games for repair or return, etc. require prior Return Authorization! Bay Tek Games will provide a Product Return Form with an authorizing Ticket Number for each item to be returned. Please be certain to include this document with all shipments!

Late Fees and Non-Return Fees - Advance Replacement and Warranty Replacement items require the defective items to be returned by Bay Tek games promptly to avoid Late Fees. We expect items to be returned with 10 working days. Late fees are invoiced monthly. Late fees are non-refundable under any circumstance! Any item not returned within 90 days will be invoiced in full as a replacement part.

Bench Fees - Bench fees will apply for each electronic item returned to Bay Tek Games (this includes unused Advance Replacement items). This charge covers our cost to inspect, evaluate and retest each item. Please note that returned items that do not pass our tests will be charged accordingly as replacement items or advance replacements.

Restocking Fees - Unused items returned for credit will be credited minus a restocking fee. Items must be returned within 30 days of purchase in order to qualify for any credit amount. No shipping charges will be credited.

WARRANTY

Bay Tek Games warrants to the original purchaser that all game components will be free of defects in workmanship and materials for a period of 6 months from the date of purchase. If you fill out the registration card in the cashbox of the game, Bay Tek will add another 3 months to your warranty, free of charge.

Bay Tek Games will, without charge, repair or replace defective component parts upon notification to the parts/service department while the game is under warranty.

Warranty replacement parts will be shipped immediately, via ground service, along with a Product Return Form for the return of defective parts.

Defective parts must be shipped back to Bay Tek Games unless otherwise instructed. Items not returned to Bay Tek Games will be invoiced as replacement parts.

This warranty does not apply in the event of any misuse or abuse to the product, or as a result of any unauthorized repairs or alterations. The warranty does not apply if any serial number decal is altered, defaced, or removed from its original position.

 **ATTENTION** 

In order to maintain the safety & compliance certifications of this game, **ONLY** approved parts may be used. For approved replacement parts, refer to the parts list in this manual.

Should you need your game serviced, determine the serial number from the decal placed on the front of this manual, or locate it on the back of the game. Then contact our Service Department at: 920.822.3951 or e-mail: service@baytekgames.com

NON-WARRANTY

Options and estimated charges will be provided to you for your approval.

Please remember that any items being sent to Bay Tek Games must include prior return authorization from our Parts & Service Department.

This approval will include a Product Return Form which is required to be included with any incoming shipments. Repaired parts will be shipped back using the same method in which they were received.

Repairs are warranted for 30 days from the date of return shipment.